

# MANUAL / NÁVOD / ANLEITUNG

GROW BOX SIZE  
VELIKOST PĚSTEBNÍHO STANU  
GROW BOX GRÖÖE

**40 x 40 x 120 cm**  
**50 x 50 x 120 cm**  
**60 x 60 x 160 cm**

## COMPONENTS / KOMPONENTY / KOMPONENTE

- A** Grow box cover / Plachta stanu / Grow box Zeltplane
- B** Floor tray / Podlážka / Zeltboden
- C** Filter straps / Úchyty na filtr / Filtergriffe
- D** Corner connectors / Rohové spojky / Eckverbinder
- 1-5** Poles / Tyče / Stangen

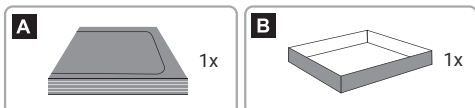

## ASSEMBLY INSTRUCTIONS / INSTRUKCE K SESTAVENÍ / AUFBAUANLEITUNG

### STEP / KROK / SCHRITT 1

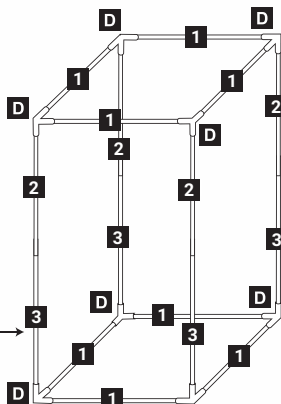
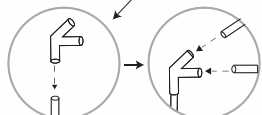
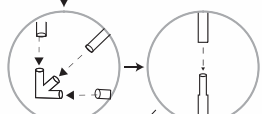

### STEP / KROK / SCHRITT 2

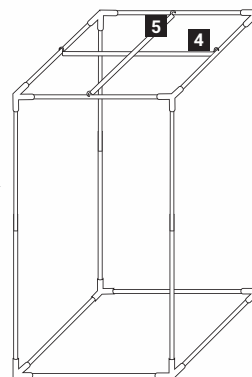
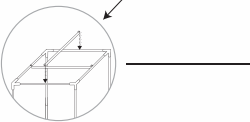
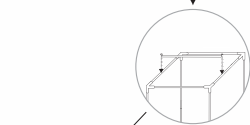

### STEP / KROK / SCHRITT 3

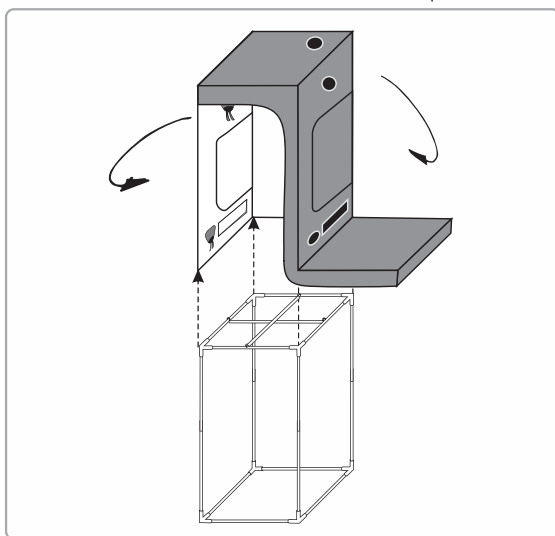
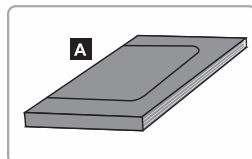
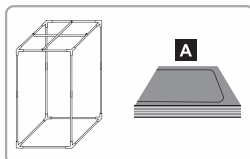

### STEP / KROK / SCHRITT 4

